

Catalogue













**SEISMIC
ISOLATOR**

 **OZDEKAN**
RUBBER IND.



**SEISMIC
ISOLATOR**

CONTENTS

-  About Us
-  Seismic Protection of Structures
-  General Features
-  Materials
-  Mathematical Modeling of HDRB Isolators
-  Mathematical Modeling of LRB Isolators
-  Performance Tables of HDRB
-  Performance Tables of LRB
-  Laboratory Tests
-  Fire Resistance
-  Maintenance
-  Referans Norms
-  Installation

ABOUT US

OZDEKAN RUBBER is one of the leading manufactures in the rubber industries since 1982. Established in Ostim Organized Industrial Zone, Ankara, and continuing engineering and manufacturing activities within the years, it has become a well-known trade mark in the Turkey and worldwide. Our company manufactures more than 2000 tons of rubber products per year and our engineers and design teams support our customers in selection of bridge bearing, providing a service beyond that of manufacturing of elastomeric bearings. Our company is capable of manufacturing different sizes of elastomeric bearings varying from 150 mm to 1500 mm in diameter with different geometrical properties. Ozdekan applies quality control tests at all phases of production process and performs required tests in conjunction with university laboratory according to different international standards. Ozdekan holds ISO 9001, ISO 14001, ISO 18001, BS OHSAS 18001 and manufacturing capacity certificate from Turkish government and trade mark. On the following pages, we provide information about seismic isolation devices. Please contact us for further information, as we are always pleased to assist our customers and consulting engineers.

Ozdekan Rubber Co.

- Elastomeric Plain Pads
- Elastomeric Bridge Bearings
- Multiflex Expansion Joint
- Lead Rubber Bearing (LRB)
- Ball Rubber Bearings (BRB)
- High Damping Rubber Bearing (HDRB)
- Vibration Lastics
- Neoprene Bands
- Earth Moving Machine Rubber Parts

Ozdekan's products are designed and tested according to the following standards;

- BS 5400
- TS-ISO-6446
- AASHTO-M251-74
- AS 5100-4
- EN 1337-3
- EN 1337-5
- DIN 4141
- EN 15129

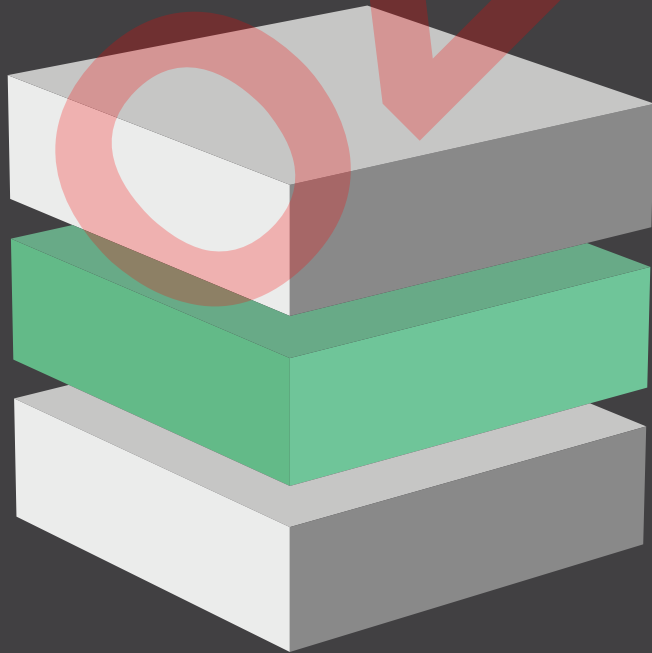

Seismic protection of structures is one of the most interesting targets for structural engineers in order to minimize property damage and save lives in case of earthquakes of high intensity. The main function of the seismic isolators is to reduce the seismic action by reducing the horizontal forces in case of earthquakes. This is possible thanks to two combined effects.

- Increasing the lateral flexibility by the use of seismic isolators between the foundation and the superstructure, the natural period is greatly increased, reducing the spectral acceleration and hence the seismic forces.
- Dissipating energy (in the form of heat) the isolator allows a reduction of the response spectrum that result in a further reduction of seismic forces.

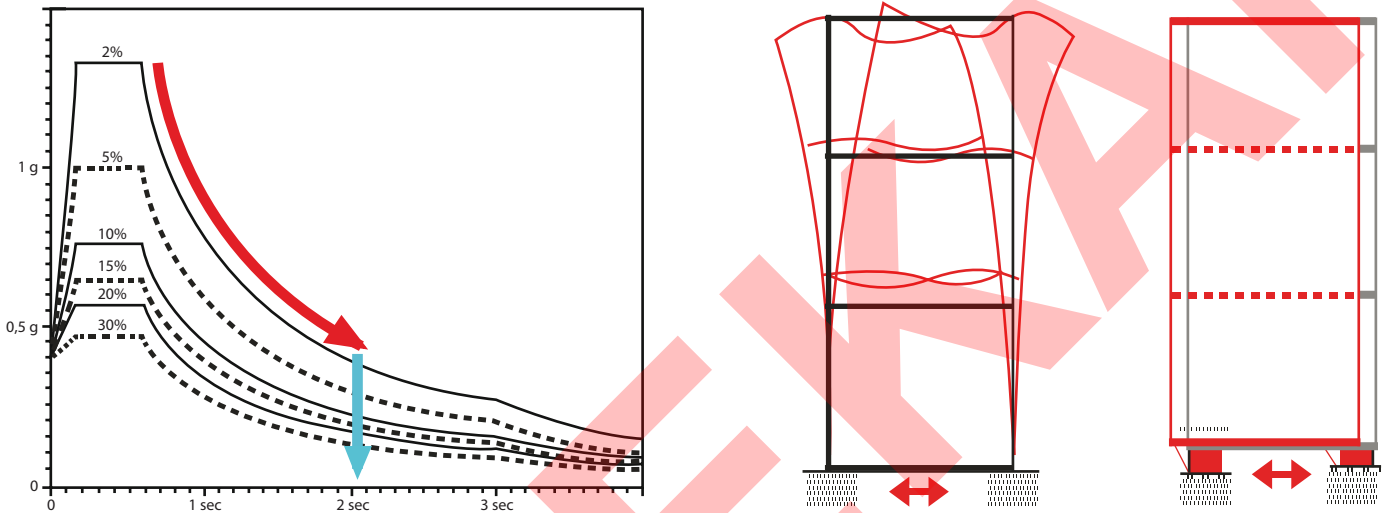

Figure 1 - Seismic Isolation Effects

1) The reduction of seismic actions in the structure has the immediate advantage of reducing the cost of the structure. The greater is the seismicity of the area, the greater is the saving. Therefore the seismic isolation is also advantageous from an economic point of view.

2) According to the European standards, if the equivalent viscous damping of an isolated structure is less than 30% it may be calculated as linear equivalent, greatly simplifying the modeling and design of the entire structure. The choice of the device is to be made accurately in relation to the specific problem in order to optimize the described features and benefits.

The main advantages of the three types of seismic isolators described in this catalogue are:

- More recentring capacity after an earthquake
- Lower stiffness to get a higher natural period

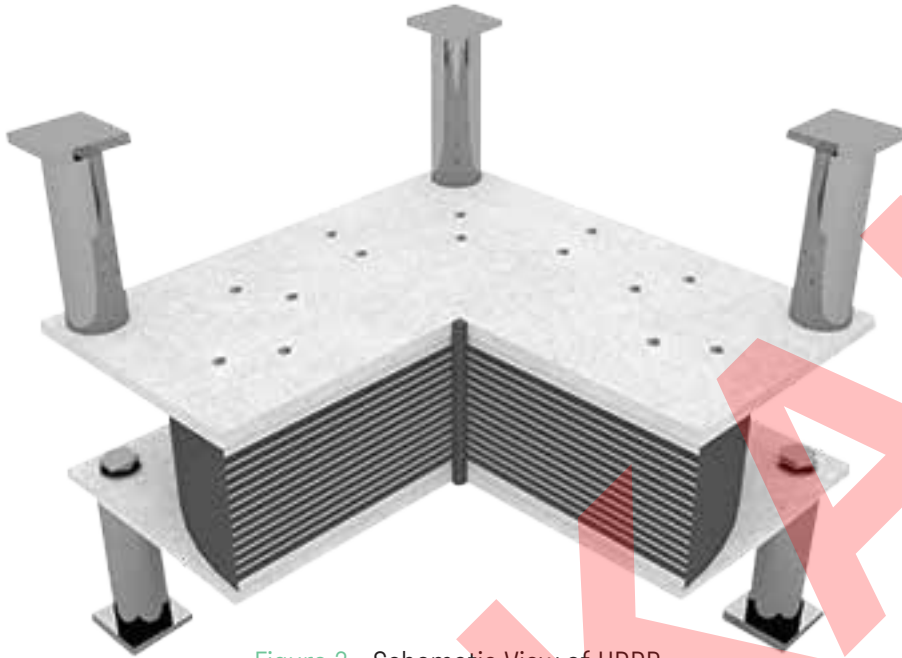

Figure 2 - Schematic View of HDRB

- Higher initial stiffness. Thanks to the lead core these devices have a rigid-plastic behavior. They therefore allow very small movement due to loads such as wind or braking.
- Higher values of damping (even greater than 30%).

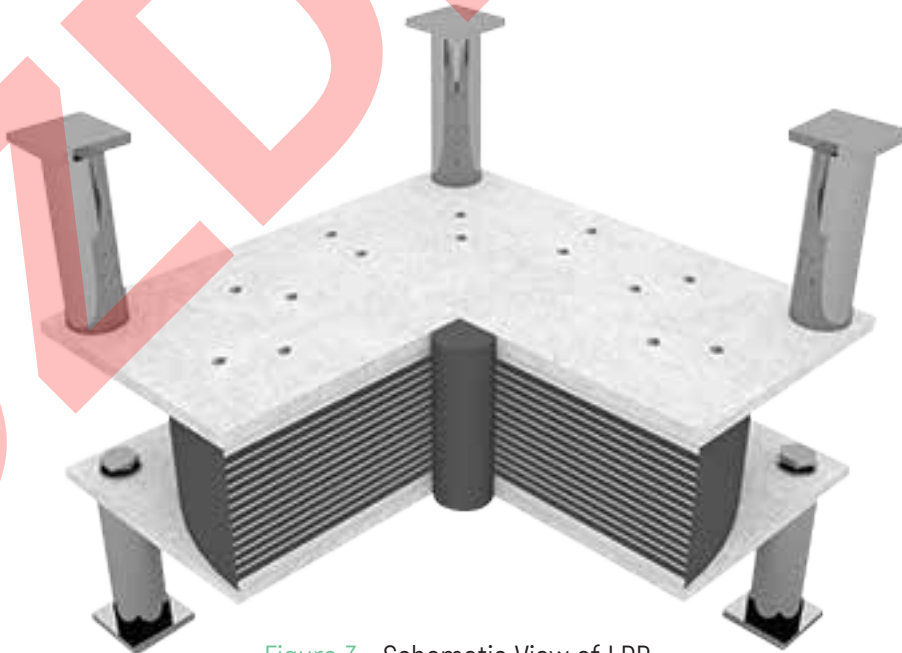

Figure 3 - Schematic View of LRB



BRB

- Provide damping up to 30% similar to lead rubber bearings
- Balls inside the core provide vertical stiffness and stability
- Balls inside the core also provide some lateral stiffness
- Seismic performance of BRB do not degrade during repetitive cyclic loads
- Ball rubber bearings (BRB) are patented by METU researchers.

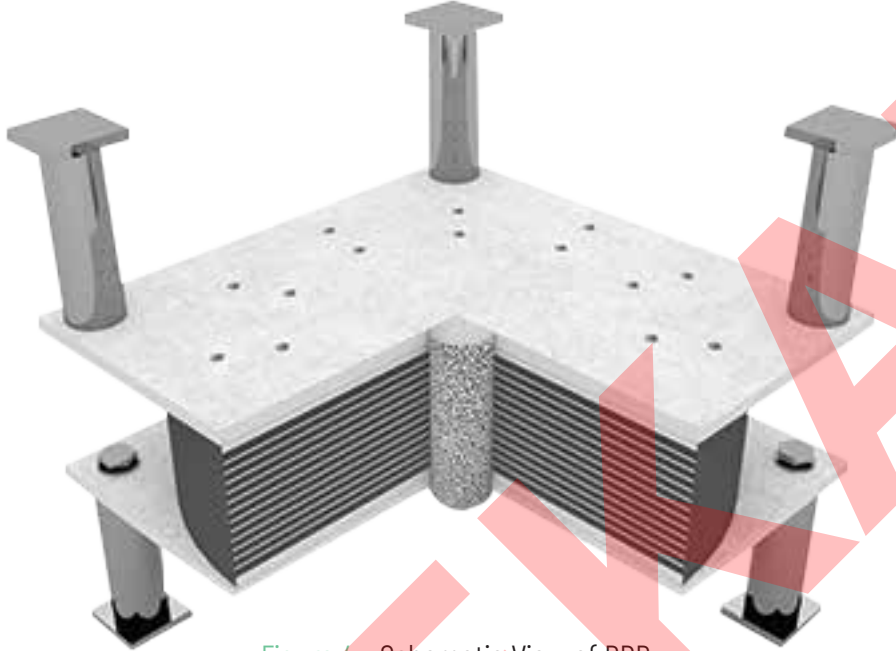

Figure 4 - Schematic View of BRB



General Features

High damping rubber bearing (HDRB) were developed in 1985 by Professor James Kelly at the University of California at Berkeley. Ozdekan was the first company which applied this technology in Turkey, using it in 2014 for the AFAD building in Ankara, Turkey. The isolating system was designed with consultation by SismoLab engineers. Ozdekan was the first company in Turkey which developed the lead rubber bearings with consultation of METU researchers.



High Damping Rubber Bearing (HDRB)

The HDRB isolators are composed of a series of vulcanized rubber layers separated by reinforcing steel plates, thus providing a device capable of supporting high vertical loads with minimal compression (elevated vertical stiffness) and allowing high horizontal displacements with relatively small reactions (low horizontal stiffness). The main property of the rubber is its ability to dissipate energy (damping capacity). When positioned underneath a building or bridge beams, they have the effect of increasing the structure's fundamental vibration period, thus greatly reducing any effects of seismic activity. The HDRB isolators are bolted to external metal plates allowing them to be fixed to the adjacent structures using anchor brackets or bolts.



These isolators are similar to the previous but with the exception that the dissipation of energy is obtained also through the use of one or more lead cores. Lead (used here at a level of 99.9% purity) has the property of undergoing plastic deformation as it dissipate energy and then re-crystallizing after a cycle of plastic deformation. Because of this, it is able to sustain an unlimited number of hysteresis loops.

 Materials

Ozdekan developed two types of rubber compounds in order to match different design needs. For HDRB 2 high dissipating compounds are available:

- Normal compound, with modulus of elasticity $G=0.7 \text{ N/mm}^2$ and 8% equivalent viscous damping (HDN isolators)
- Hard compound, with modulus of elasticity $G=1.1 \text{ N/mm}^2$ and 6% equivalent viscous damping (HDH isolators)

For the LRB isolators 2 type of compound are available:

- Normal compound, with modulus of elasticity $G=0.7 \text{ N/mm}^2$ and 8% equivalent viscous damping (LRN isolators)
- Hard compound, with modulus of elasticity $G=1.1 \text{ N/mm}^2$ and 6% equivalent viscous damping (LRH isolators)

Table 1 - Rubber Compound Physical-Mechanical Characteristic

Rubber Compound Physical-Mechanical Characteristic		Compound	
		Normal	Hard
Hardness	Shore A3	60±3	70±3
Tensile Strength	N/mm^2	20	18
Tensile Strain	%	600	500
Shear Modulus	N/mm^2	0.7	1.1
Viscous Damping of the Rubber	%	8	6
Corresponding Isolator		HDN	HDH

In this page typical hysteresis diagrams for an HDRB and an LRB are presented. The technical parameters are indicated in the dimensional tables in the following pages. In the LRB diagram you may notice the lead core and the rubber's contribution.



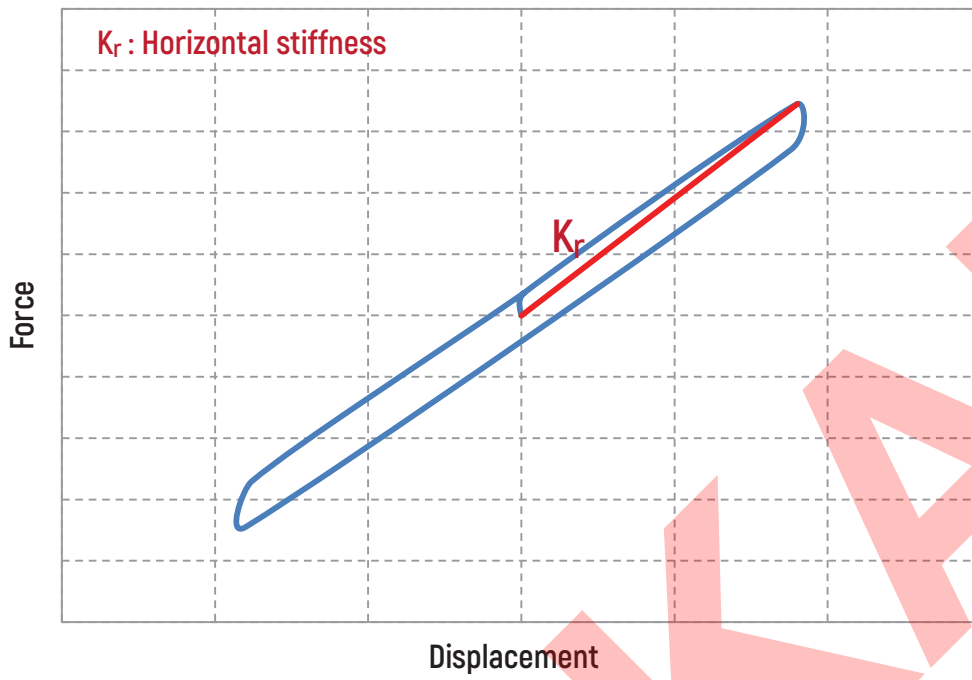

Figure 5 - Force-Displacement Diagram for HDRB

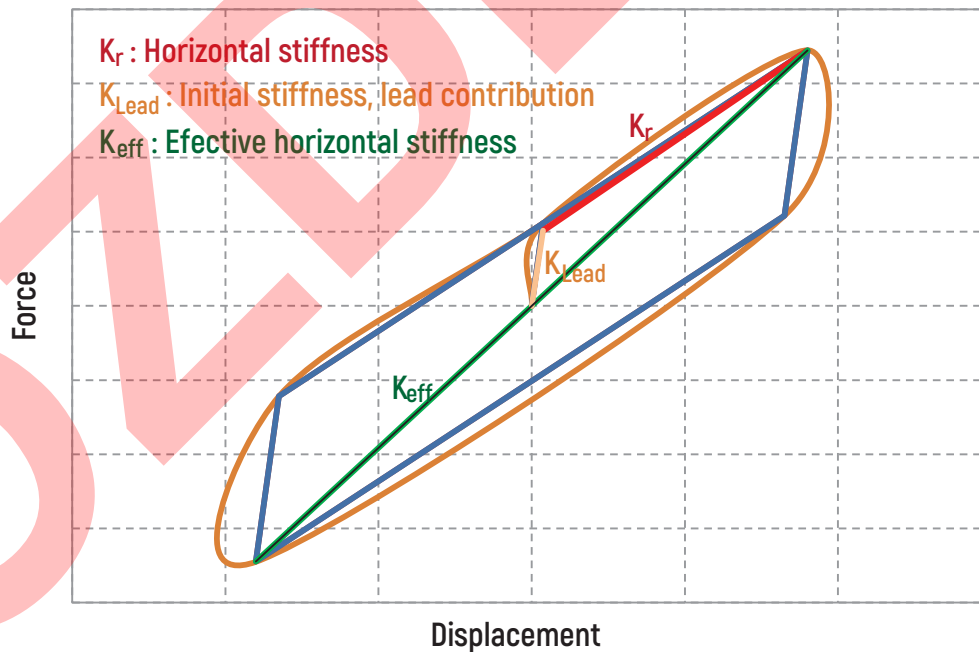

Figure 6 - Force-Displacement Diagram for LRB

HDRB isolators can always be modeled as linear equivalent by expressing their characteristics in terms of two synthetic parameters:

- K_r Horizontal stiffness,
- ξ equivalent viscous damping

Values for these parameters are given in the tables on the following pages in correspondence with various geometries and compositions. Note that the values given in the tables are referenced to a temperature of +20°C and a shear deformation of 100%. The value for K_r may need to be modified to fit to different conditions; in such case the value can be taken from the below reported plots.

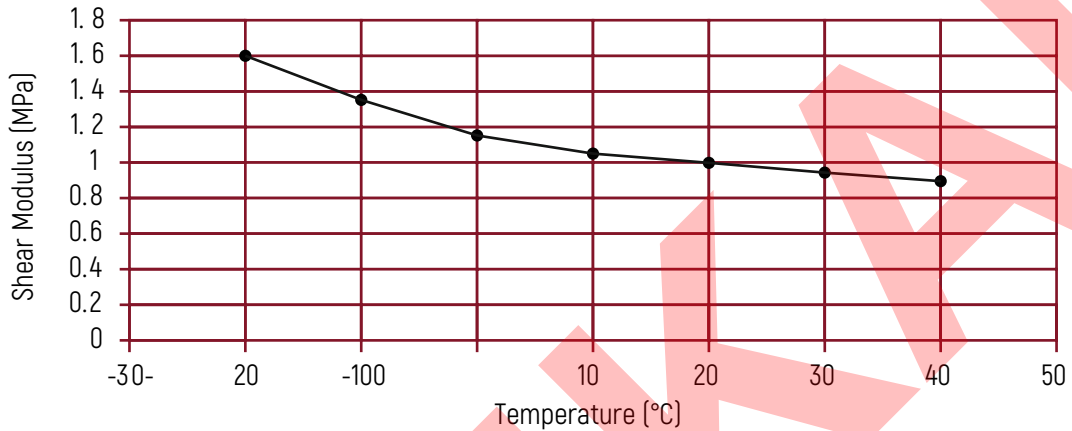

Figure 7 - Relative Variation of Stiffness as a Function of Temperature

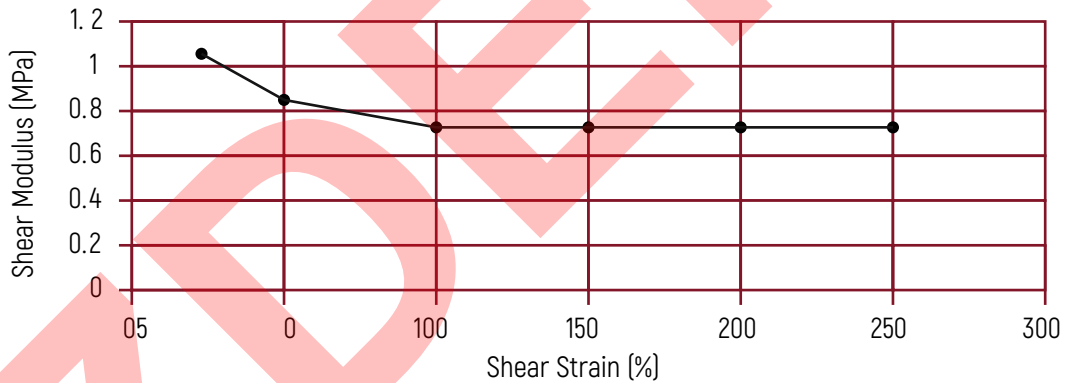

Figure 8 - Relative Variation of Stiffness as a Function of Shear Deformation

Their behaviour can be defined throughout the following parameters.

- K_r Horizontal stiffness (elastomer contribution)
- Q Characteristic strength of isolator

The values for these parameters are given in the dimensional tables in the following pages. The linear equivalent calculation, under the same hypothesis, can be made with the same procedure given in the previous paragraph for the HDRB isolators but with these differences:

- Instead of K_r consider the effective horizontal stiffness K_{eff}
- Instead of ξ consider the effective damping β

Keep in mind that LRB isolators are strongly non-linear. This means that parameters K_{eff} and β values as indicated in the dimension tables are valid only for the design displacement S_{max} . Therefore you have to perform again the modal analysis even if your calculated displacement is lower than the hypothesized.





The following tables report the typical characteristics for the most commonly used isolators, those of circular shape. Isolators with different characteristics rather of square or rectangular shape or to resolve specific structural problems as for instance uplift loads can be produced on request.

The HDRB code is composed as follows:

HD"X" D* T_r , where:

"X" is the rubber compound used, "N" for normal and "H" for hard.

D is the isolator diameter (mm)

T_r is the total thickness of elastomer layers (mm)

For example HDH 1200*120 stands for an isolator type HDRB with a hard compound with modulus of elasticity $G=1.1$ N/mm², diameter 1200 mm and total elastomer thickness of 120 mm.

Legend

HDN (High Damping Normal)

G: 0.7N/mm² - $\xi=8\%$

HDH (High Damping Hard)

G: 1.1N/mm² - $\xi=6\%$

Technical Data

V_{sis} : Vertical load under seismic conditions

K_r : Horizontal stiffness

S_{max} : Design Displacement

ξ : viscous damping of the rubber

Geometrical Data

D: Diameter of the isolator

H: Overall height of the isolator

T_r : Thickness of the elastomer

B: Overall dimension of the isolator in two directions

Z: Distance between centers of anchorages in two directions

B: $D+50$

Z: $0.75*B$

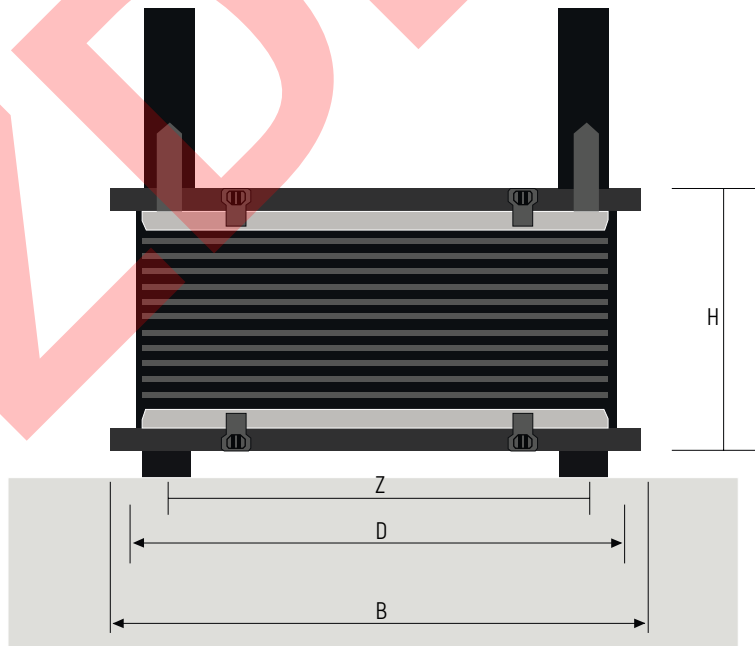

Table 2 - HDRB Performance Table

HDN (G:0.7)	V _{sis}	K _r	S _{max}	H	T _r	HDN (G:0.7)	V _{sis}	K _r	S _{max}	H	T _r	HDN (G:0.7)	V _{sis}	K _r	S _{max}	H	T _r
D:300						D:600						D:1000					
300*48	1200	1.03	100	132	48	600*120	3900	1.74	240	265	120	1000*120	15300	4.75	240	295	120
300*54	1050	0.96	110	140	54	600*132	3200	2.8	260	282	132	1000*140	14300	4.44	280	324	140
300*60	900	0.9	120	148	60	600*144	2900	1.49	280	300	144	1000*160	12000	3.73	320	360	160
300*66	750	0.75	130	156	66	600*156	2500	1.28	300	306	156	1000*180	11000	3.41	360	398	180
300*72	650	0.69	140	164	72	600*168	2200	1.21	320	323	168	1000*200	9800	3.04	400	429	200
300*78	590	0.65	150	172	78	600*180	1950	1.16	340	340	180	1000*220	8800	2.73	440	450	220
D:350						D:650						D:1100					
350*49	1700	1.55	100	143	49	650*143	3900	1.74	280	303	143	1100*110	18200	6.72	220	272	110
350*56	1550	1.41	120	154	56	650*156	3600	1.61	300	312	156	1100*132	17300	6.02	270	307	132
350*63	1400	1.16	140	165	63	650*169	3100	1.39	320	331	169	1100*154	16000	4.92	310	344	154
350*70	1300	1.19	150	176	70	650*182	2700	1.29	340	337	182	1100*176	15000	4.18	360	383	176
350*77	1150	1.05	160	187	77	650*195	2300	1.22	360	355	195	1100*198	14000	3.7	400	416	198
350*84	900	0.82	170	198	84	650*208	2100	1.12	380	373	208	1100*220	13000	3.27	440	458	220
D:400						D:700						D:1200					
400*48	2300	2.1	100	138	48	700*140	4600	2.06	280	302	140	1200*120	21800	7.16	240	286	120
400*56	2000	1.82	120	150	56	700*154	4200	1.88	310	314	154	1200*144	20000	6.57	290	324	144
400*64	1900	1.44	140	162	64	700*168	3900	1.74	340	335	168	1200*168	19200	5.35	340	364	168
400*72	1800	1.37	150	174	72	700*182	3550	1.59	370	344	182	1200*192	18500	4.65	390	406	192
400*80	1650	1.15	160	195	80	700*196	3000	1.43	400	364	196	1200*216	17400	3.97	440	442	216
400*88	1400	1.06	170	198	88	700*210	2650	1.36	420	370	210						
D:450						D:750						D:1400					
450*48	3000	2.49	100	133	48	750*120	8000	2.63	240	266	120	1400*140	29600	8.25	280	310	140
450*56	2700	2.24	120	150	56	750*135	7350	2.41	270	289	135	1400*168	27000	7.52	340	358	168
450*64	2500	1.9	140	162	64	750*150	6350	2.09	290	312	150	1400*196	25000	6.29	400	404	196
450*72	2400	1.68	160	182	72	750*165	5500	2.03	310	335	165	1400*224	24000	5.22	450	352	224
450*80	2200	1.54	180	195	80	750*180	4700	1.74	350	347	180	1400*252	23000	4.57	510	502	252
450*88	2100	1.35	200	208	88	750*195	4100	1.72	380	369	195						
D:500						D:800											
500*80	3900	2	160	205	80	800*112	9600	3.15	230	270	112						
500*90	3550	1.82	180	220	90	800*128	9100	3.09	260	294	128						
500*100	2950	1.63	200	244	100	800*144	8300	2.72	290	326	144						
500*110	2550	1.43	220	250	110	800*160	7100	2.33	320	351	160						
500*120	2550	1.34	240	265	120	800*176	5800	2.16	360	366	176						
500*130	1950	1.22	260	280	130	800*192	5000	1.84	400	384	192						
D:550						D:900											
550*99	4200	2.15	200	237	99	900*108	12200	4.24	220	258	108						
550*110	3500	1.8	220	254	110	900*126	12000	3.94	360	284	126						
550*121	3050	1.62	240	271	121	900*144	11000	3.23	290	317	144						
550*132	2350	1.35	260	277	132	900*162	10000	2.94	330	352	162						
550*143	2100	1.25	280	293	143	900*180	9100	2.67	360	380	180						
550*154	1800	1.1	300	309	154	900*198	7500	2.46	400	398	198						



The following tables report the typical characteristics for the most commonly used isolators, those of circular shape. Isolators with different characteristics rather of square or rectangular shape or to resolve specific structural problems as for instance uplift loads can be produced on request.

The LRB code is composed as follows:

LR"X" D* T_r , where:

"X" is the rubber compound used, "N" for normal

D is the rubber diameter (mm)

T_r is the total thickness of elastomer layers (mm)

For example LRN 1200*120 stands for an isolator type LRB with a Normal compound with modulus of elasticity $G=0.7N/mm^2$, diameter D 1200 mm and total elastomer thickness of 120 mm.

Legend

LRN (High Damping Normal)

G: $0.7N/mm^2$ - $\xi=7\%$

Technical Data

V_{sis} : Vertical load under seismic conditions

K_r : Horizontal stiffness (elastomer contribution)

K_{eff} : Effective horizontal stiffness

S_{max} : Design Displacement

Q: Characteristic strength of lead core

ξ : Viscous damping of the rubber

β_{eff} : Effective damping

β_{eff} : 25%

Geometrical Data

D: Diameter of the isolator

H: Overall height of the isolator

T_r : Thickness of the elastomer

B: Overall dimension of the isolator in two directions

Z: Distance between centers of anchorages in two directions

B: $D+50$

Z: $0.75*B$

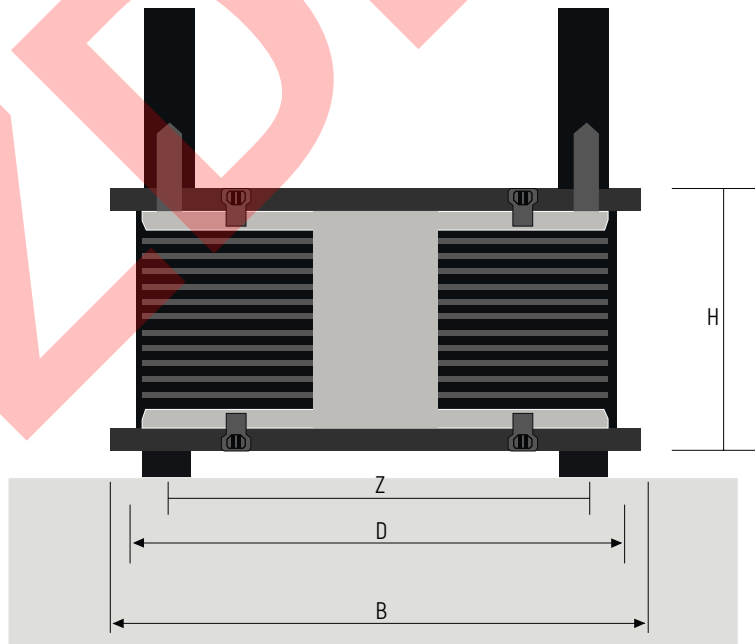

Table 3 - LRBs Performance Table

LRN (G:0.7)	V _{sis}	K _r	Q	K _{eff}	S _{max}	H	T _r
D:300							
300*48	1000	1.07	60	1.67	100	146	48
300*54	900	1.02	54	1.51	110	156	54
300*60	800	0.89	54	1.34	120	166	60
300*66	740	0.82	59	1.24	140	176	66
300*72	660	0.75	53	1.1	150	176	72
300*78	600	0.67	54	1	160	184	78
D:350							
350*49	1400	1.53	73	2.26	100	146	49
350*56	1300	1.29	76	1.92	120	154	56
350*63	1200	1.12	77	1.67	140	165	63
350*70	1100	1.02	76	1.53	150	176	70
350*77	1000	0.88	74	1.34	160	187	77
350*84	900	0.82	69	1.22	170	198	84
D:400							
400*48	2000	1.89	90	2.78	100	165	48
400*56	1900	1.67	99	2.49	120	181	56
400*64	1800	1.5	103	2.23	140	203	64
400*72	1700	1.24	98	1.89	150	220	72
400*80	1600	1.1	94	1.69	160	245	80
400*88	1500	1.01	90	1.51	180	263	88
D:450							
450*48	2500	2.63	130	3.93	100	138	48
450*56	2400	2.08	125	3.12	120	150	56
450*64	2300	1.78	119	2.7	130	169	64
450*72	2200	1.55	115	2.33	150	182	72
450*80	2100	1.44	114	2.16	160	195	80
450*88	2000	1.27	113	1.9	180	218	88
D:500							
500*80	3100	1.74	150	2.68	160	212	80
500*90	3000	1.54	145	2.35	180	228	90
500*100	2900	1.39	156	2.17	200	244	100
500*110	2800	1.25	136	1.87	220	260	110
500*120	2700	1.15	138	1.73	240	276	120
500*130	2600	1.06	135	1.58	260	280	130
D:550							
550*99	3400	1.68	175	2.55	200	245	99
550*110	3300	1.52	169	2.3	220	263	110
550*121	3200	1.38	164	2.07	240	281	121
550*132	3100	1.26	162	1.88	260	288	132
550*143	3000	1.17	156	1.77	280	305	143
550*154	2900	1.09	155	1.6	300	309	154
D:600							
600*120	3900	1.66	203	2.51	240	282	120
600*132	3600	1.51	193	2.25	260	292	132
600*144	3400	1.38	188	2.06	280	311	144
600*156	3200	1.28	185	1.89	300	318	156
600*168	3000	1.18	182	1.76	320	336	168
600*180	2800	1.11	195	1.68	340	340	180
D:650							
650*143	4200	1.62	248	2.51	280	313	143
650*156	3900	1.5	233	2.27	300	300	156
650*169	3600	1.38	223	2.08	320	320	169
650*182	3300	1.28	214	1.91	340	340	182
650*195	3000	1.2	218	1.8	360	360	195
650*208	2700	1.12	214	1.69	380	380	208

LRN (G:0.7)	V _{sis}	K _r	Q	K _{eff}	S _{max}	H	T _r
D:700							
700*140	5000	1.96	290	2.97	280	311	140
700*154	4500	1.76	281	2.68	310	324	154
700*168	4100	1.61	289	2.46	340	346	168
700*182	3800	1.49	278	2.24	370	356	182
700*196	3500	1.38	274	2.07	400	377	196
700*210	3100	1.29	275	1.94	420	384	210
D:750							
750*120	6300	2.6	324	3.95	240	273	120
750*135	5900	2.31	314	3.47	270	297	135
750*150	5600	2.07	298	3.1	290	321	150
750*165	5300	1.88	294	2.83	310	345	165
750*180	5000	1.73	299	2.58	350	358	180
750*195	4700	1.59	301	2.39	380	381	195
D:800							
800*112	7000	3.17	399	4.91	230	276	112
800*128	6600	2.77	377	4.22	260	301	128
800*144	6300	2.46	360	3.7	290	334	144
800*160	6000	2.21	356	3.32	320	360	160
800*176	5700	2.01	360	3.01	360	376	176
800*192	5400	1.84	367	2.76	400	396	192
D:900							
900*108	10000	4.16	494	6.41	220	263	108
900*126	9500	3.56	469	5.37	260	296	126
900*144	9000	3.1	468	4.72	290	324	144
900*162	8500	2.76	472	4.2	330	360	162
900*180	8000	2.49	444	3.72	360	389	180
900*198	7500	2.26	448	3.38	400	418	198
D:1000							
1000*120	12000	4.62	619	7.2	240	300	120
1000*140	11000	3.95	568	5.98	280	336	140
1000*160	10000	3.46	550	5.18	320	367	160
1000*180	9000	3.06	569	4.64	360	406	180
1000*200	8000	2.76	560	4.16	400	438	200
1000*220	7000	2.51	544	3.75	440	470	220
D:1100							
1100*110	14000	6.1	735	9.45	220	276	110
1100*132	13000	5.08	804	8.06	270	317	132
1100*154	12500	4.35	837	7.05	310	356	154
1100*176	12000	3.72	803	5.95	360	390	176
1100*198	11500	3.38	770	5.3	400	432	198
1100*220	11000	3.04	736	4.71	440	476	220
D:1200							
1200*120	16000	6.65	868	10.3	240	290	120
1200*144	15500	5.54	1005	9	290	334	144
1200*168	15000	4.74	921	7.45	340	376	168
1200*192	14500	4.14	890	6.43	390	420	192
1200*216	14000	3.68	860	5.64	440	458	216
D:1400							
1400*140	23000	7.75	1071	11.58	280	318	140
1400*168	22500	6.45	1130	9.77	340	363	168
1400*196	22000	5.25	1132	8.86	400	416	196
1400*224	21500	4.83	1302	7.73	450	466	224
1400*252	21000	4.29	1272	6.79	510	518	252



Laboratory Tests

Ozdekan's HDRB and LRB isolators are subjected to rigorous quality controls, as listed in the following table.

The tests are divided into:

- Prototype tests performed by Ozdekan for the definition of the technical characteristics;
- Production tests, which are performed on 20% of the produced isolators in order to verify their correspondence to project characteristics (some norms require different test frequencies: for example, AASHTO requires 100%)

Table 4 - Laboratory Tests

Test	Prototype Test	Production Control
Compression at zero displacement	*	
Stiffness K_r	*	20%
K_r and ξ_r for cyclic deformation	*	20%
K for incremental load	*	20%
Variation of K_r and ξ_r with frequency	*	
Variation of K_r and ξ_r with temperature	*	
Variation of K_r and ξ_r with cyclic loads	*	
Horizontal deformation with V_{min} and V_{max}	*	
Variation of K_r and ξ_r over time	*	
Viscous deformation with vertical load	*	

Fire Resistance

If necessary the Ozdekan HDRB and LRB can be protected from the fire by application of special fire resistant panels.

Maintenance

Ozdekan HDRB and LRB isolators do not require any special maintenance. An inspection is needed however at least once every 5 years or after an exceptional event such as earthquake, flood or fire. A lateral deformation of an isolator that shows the internal stratification is perfectly normal. If there are irregular deformations, these must be brought to the attention of an expert. If necessary, the anti-corrosion protection for the external metallic plates shall be restored.

Reference Norms

Ozdekan's HDRB and LRB isolators respond principally to EN15129. The HDRB and LRB isolators produced by Ozdekan can also be made according to other norms, such as AASHTO or ISO 22762.

The principal steps for the most frequent cases:

1. Casting of the infrastructure up to a level a few centimeters lower than the final level of the isolators. Tubes for example corrugated steel sheets of double diameter than the anchors shall be left in the concrete at the positions of the anchor brackets;

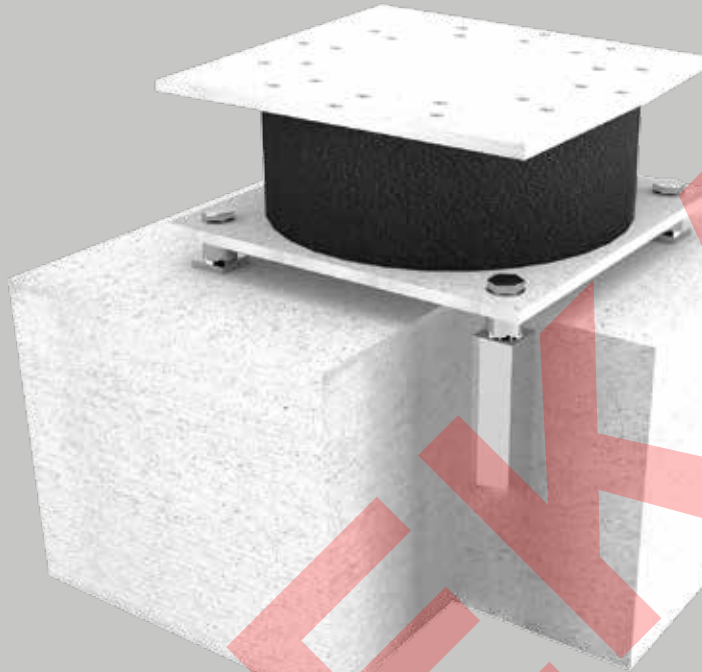

2. Positioning of the isolators at the proper level with the aid of wedges or regulating screws and placing of a formwork surrounding the isolator;

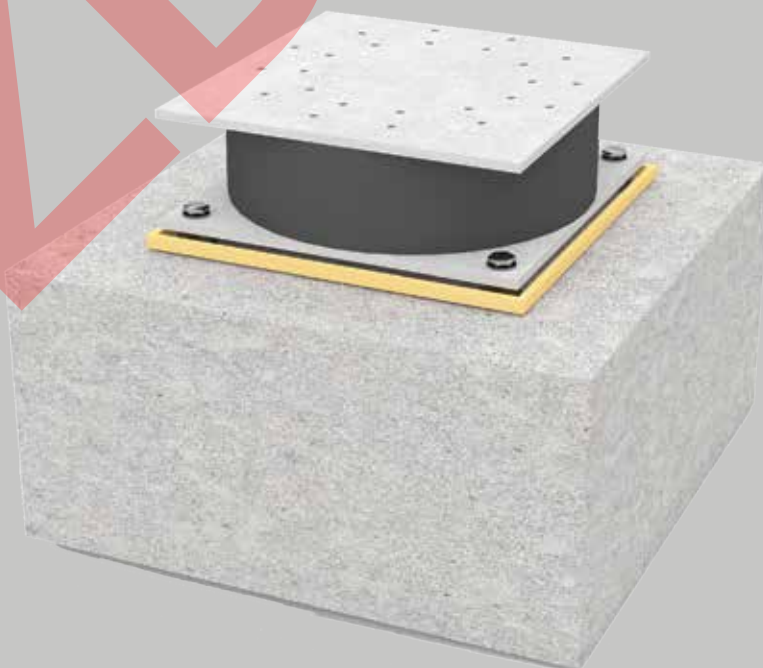

3. Casting of the joint in the non-shrink mortar or epoxy mortar. The mortar joint shall not be reinforced if its thickness is less or equal to the following values:

. 50 mm or

. $0.1 * \frac{\text{surface contact area}}{\text{perimeter of contact area}} + 15 \text{ mm, in millimeters}$

whichever is smaller

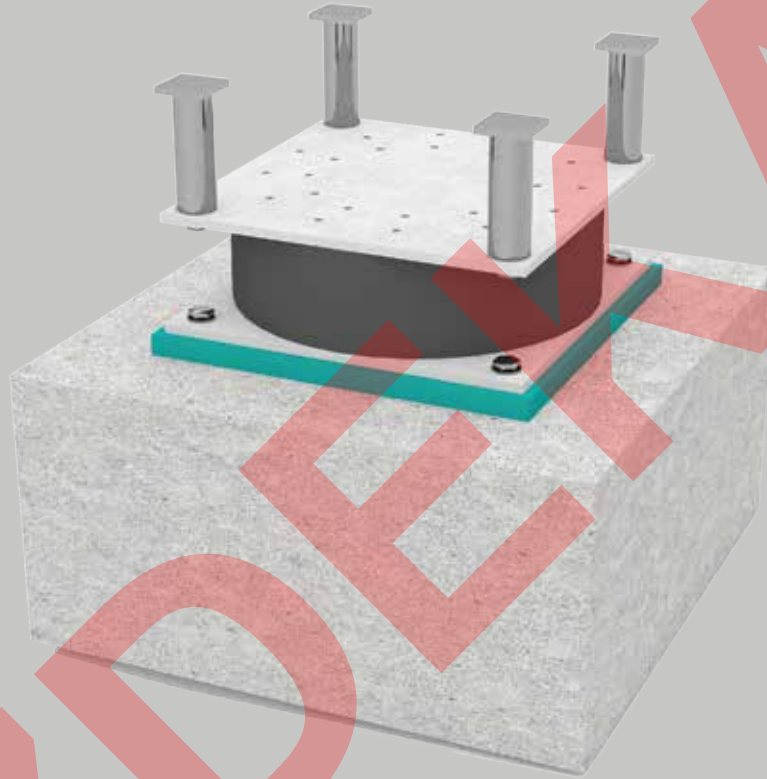

4. Placing of the formwork of the superstructure and sealing it around the isolator.

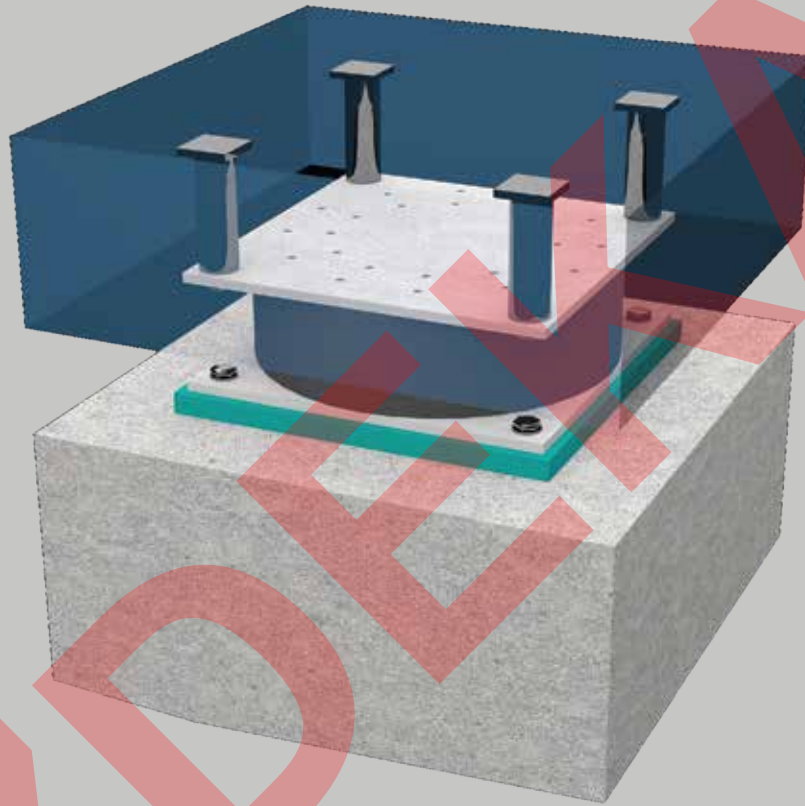

5. Casting the superstructure.

For further details, please see EN 1337-11.



Designed and Printed by:

 Ailuros AdWorks

www.ailurosadworks.com



ÖZDEKAN

RUBBER IND.

Phone:

+ 90 0312 354 06 44

Adres:

Ostim Organize Sanayi Bölgesi, 1202/2. Cadde No:30-32 Yenimahalle/Ankara Türkiye

www.ozdekan.com - www.orubber.com